

NEW

RIEGL miniVUX[®]-3UAV

- **100 kHz / 200 kHz / 300 kHz Laser PRR selectable**
- **measurement rate up to 200,000 measurements/sec**
- **scan speed up to 100 scans/sec**
- **very compact & lightweight (1.55 kg / 3.4 lbs)**
- **up to 360° field-of-view**
- **robust aluminum housing, ready to be mounted on multi-rotor, rotary-wing, and fixed-wing UAVs**
- **makes use of RIEGL's unique echo signal digitization and online waveform processing**
- **multiple target capability – up to 5 target echoes per laser shot**
- **mechanical and electrical interface for IMU mounting**
- **exceptionally well suited to measure in snowy and icy terrains**
- **user-friendly, application- and installation-oriented solutions for integration**

The *RIEGL* miniVUX-3UAV is an extremely lightweight airborne laser scanner, designed specifically for integration with UAS/UAV/RPAS. The sister type of the proven *RIEGL* miniVUX-2UAV and *RIEGL* miniVUX-1UAV sensor offers a selectable 100 kHz, 200 kHz, and 300 kHz laser pulse repetition rate (PRR). With 300 kHz PRR, the sensor provides up to 100,000 measurements per second at 120° FoV and thus a dense point pattern on the ground for UAV-based applications that require the acquisition of small objects.

The small and sophisticated design of the stable aluminum housing offers various integration possibilities with platforms that offer restricted space or payload capabilities. The 360° field of view allows complete acquisition of the environment.

An easy-to-remove SD card for data storage, and/or the option for streaming the scan data via LAN-TCP/IP interface, in combination with the modest power consumption of the scanner, enable straight-forward integration with most UAS/UAV/RPAS types.

The *RIEGL* miniVUX-3UAV makes use of *RIEGL*'s unique Waveform-LiDAR technology, allowing echo digitization and online waveform processing. Multi-target resolution is the basis for penetrating even dense foliage. As a further special feature, the wavelength is optimized for the measurement of snowy and icy terrain.

In addition to the stand-alone version of the miniVUX-3UAV, *RIEGL* also offers fully-integrated system solutions.

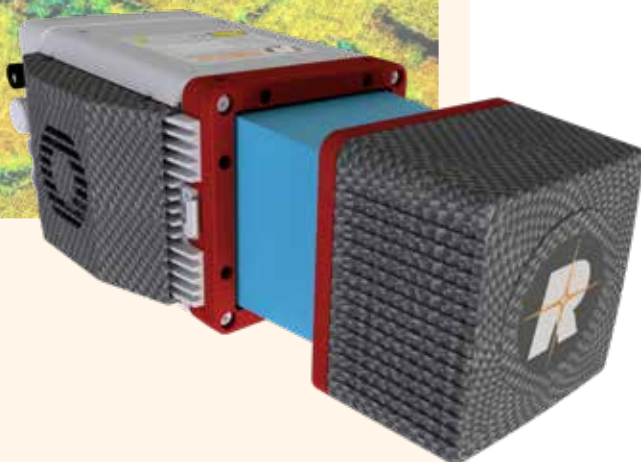

Typical applications include

- **Agriculture & Forestry**
- **Glacier and Snowfield Mapping**
- **Archeology and Cultural Heritage Documentation**
- **Construction-Site Monitoring**
- **Landslide Monitoring**

visit our website
www.riegl.com



Maximum Measurement Range vs. Target Reflectance *RIEGL miniVUX®-3UAV*

PRR = 100 kHz

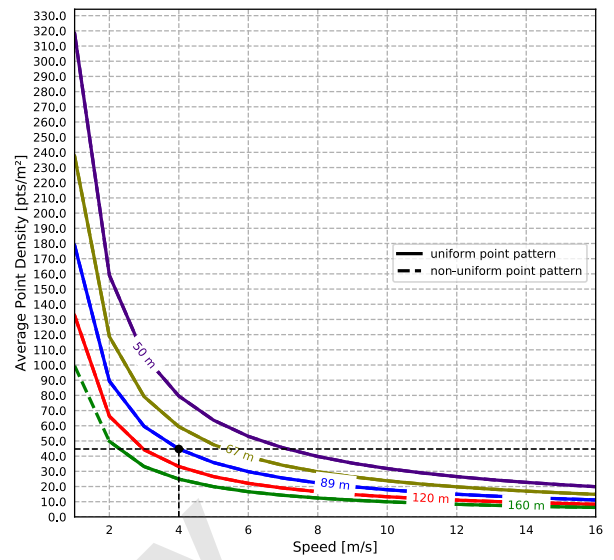
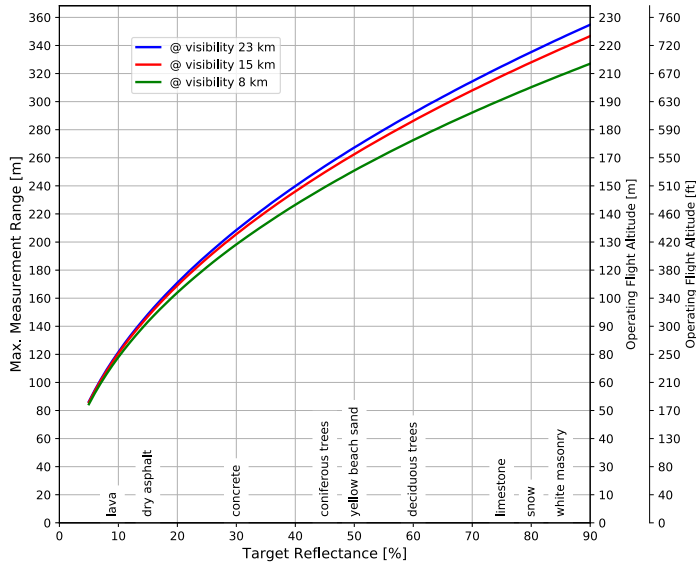

Example: miniVUX-3UAV at 100,000 pulses/second, range to target = ~90 m, speed = 4 m/s

Resulting Point Density ~ 45 pts/m²

PRR = 200 kHz reduced power

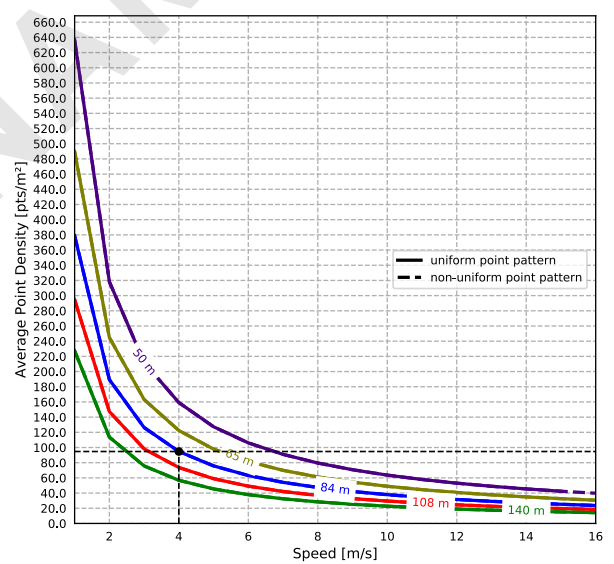
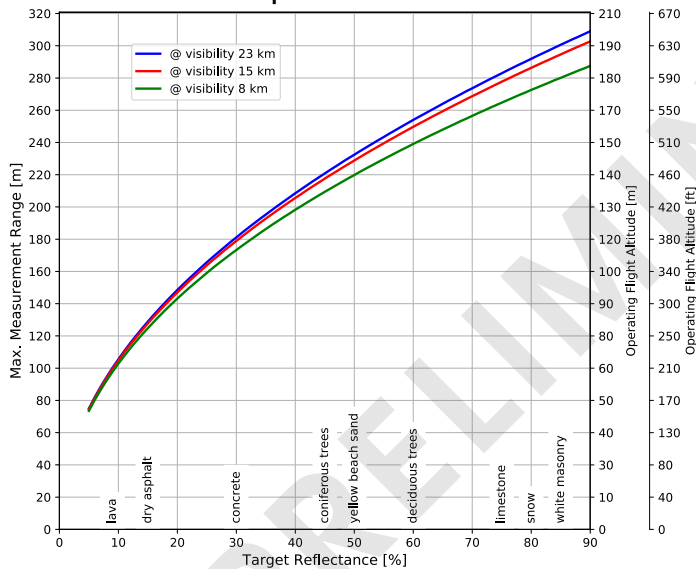

Example: miniVUX-3UAV at 200,000 pulses/second, range to target = ~85 m, speed = 4 m/s

Resulting Point Density ~ 95 pts/m²

PRR = 200 kHz

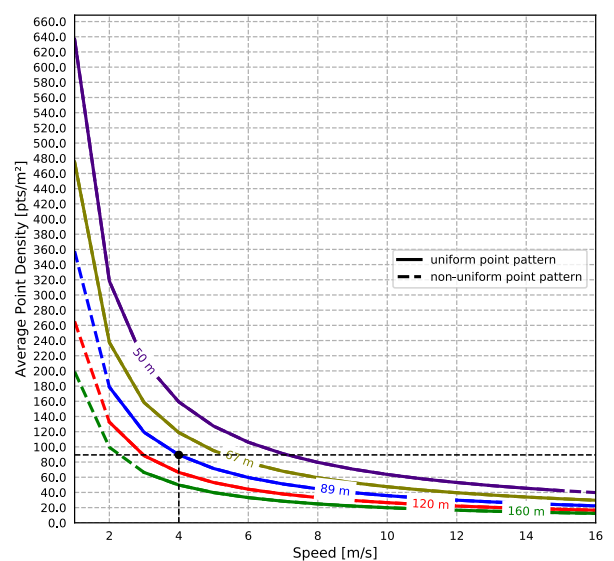
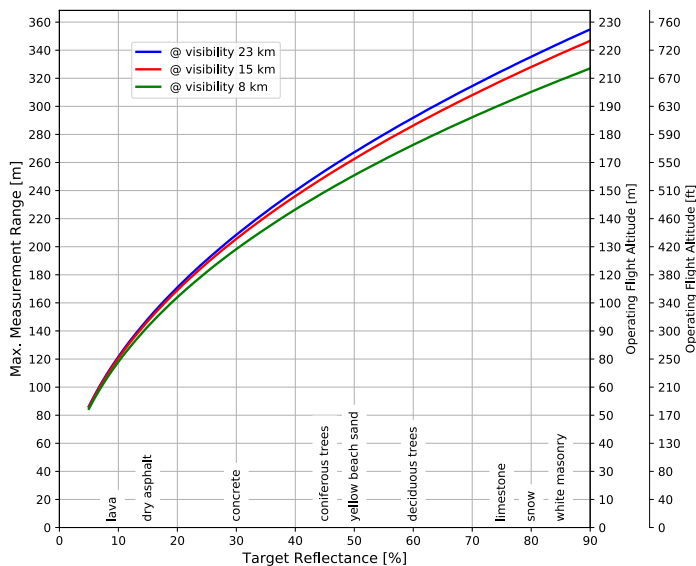

Example: miniVUX-3UAV at 200,000 pulses/second, range to target = ~90 m, speed = 4 m/s

Resulting Point Density ~ 90 pts/m²

Maximum Measurement Range vs. Target Reflectance RIEGL miniVUX®-3UAV

PRR = 300 kHz

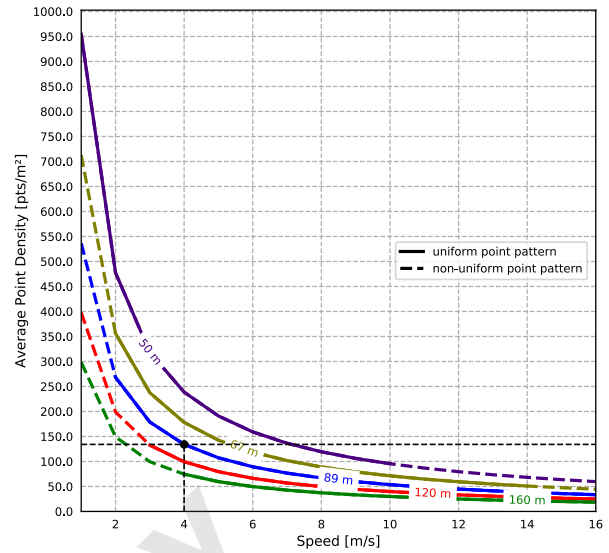
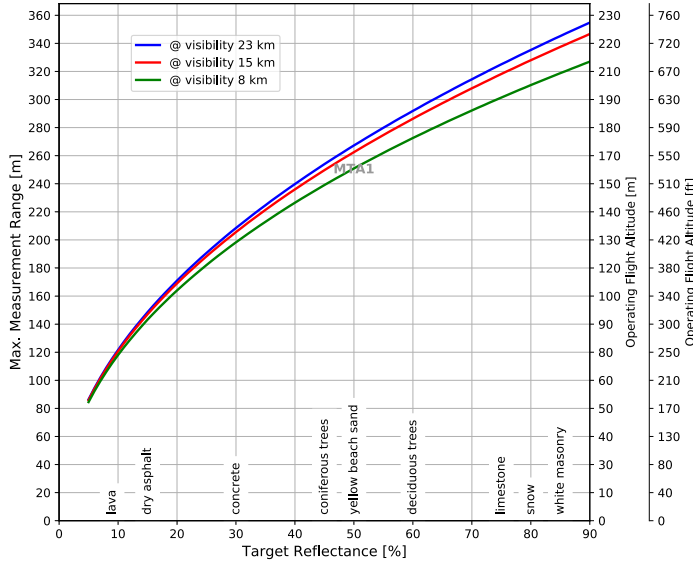

Example: miniVUX-3UAV at 300,000 pulses/second, range to target = ~90 m, speed = 4 m/s

Resulting Point Density ~ 135 pts/m²

RIEGL miniVUX-SYS System Integration Options

Besides of the stand-alone miniVUX-3UAV LiDAR engine, RIEGL offers also system solutions, combining the miniVUX-3UAV with IMU/GNSS systems of different performance and of different form factors as well as optional RGB camera systems. Additionally, a special add-on to the miniVUX-SYS allows for straight forward integration with your multi-rotor UAV, e.g. a DJI Matrice M600.

RIEGL miniVUX-3UAV with APX-15 UAV¹⁾



- IMU/GNSS unit integrated with LiDAR engine
- total weight approx. 2 kg
- interfaces for up to 2 cameras
- suited for integration into fixed-wing UAVs

RIEGL miniVUX-3UAV with APX-20 UAV¹⁾

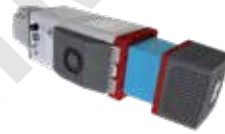

- higher-grade IMU/GNSS unit partly integrated with LiDAR engine
- total weight approx. 2.5 kg
- interfaces for up to 2 cameras
- suited for integration into all types of UAVs

RIEGL Integration Kit 600



- add-on to the miniVUX-SYS coming with shock-absorbing mounting-kit, power supply module and cabling
- total weight approx. 0.7 kg (without sensor and camera)
- suited for integration into multi-rotor UAVs

Please contact sales@riegl.com to get more detailed information.

¹⁾ See technical details in the corresponding Applanix datasheet

RIEGL miniVUX®-3UAV Camera Options

RIEGL miniVUX-3UAV LiDAR Sensor equipped with APX-15 UAV¹⁾



with two Sony Alpha 6000 cameras (oblique mount)



with nadir-looking camera e.g. Sony Alpha 6000 camera or Sony Alpha 7R III

RIEGL miniVUX-3UAV LiDAR Sensor equipped with APX-20 UAV¹⁾



with two Sony Alpha 6000 cameras (oblique mount)



with nadir-looking camera e.g. Sony Alpha 6000 camera or Sony Alpha 7R III

¹⁾ See technical details in the corresponding Applanix datasheet

bottom view

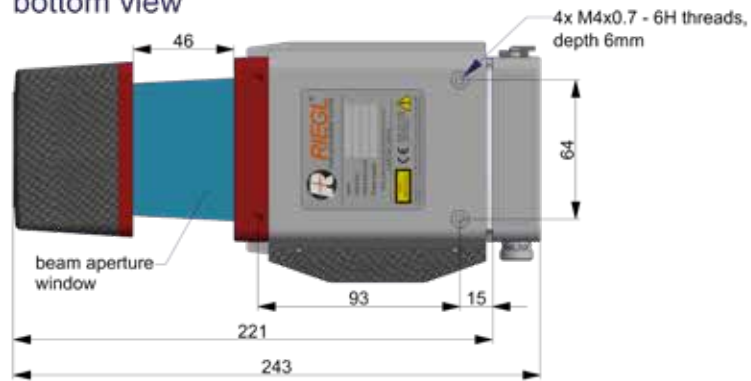

rear view

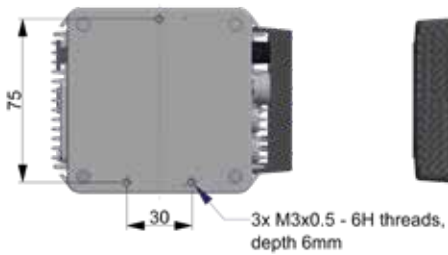

side view

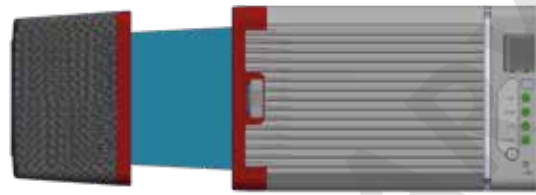

front view

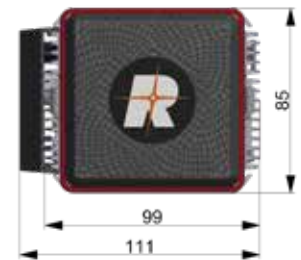

top view



all dimensions in mm

Laser Product Classification

Class 1 Laser Product according to IEC 60825-1:2014

The following clause applies for instruments delivered into the United States:
Complies with 21 CFR 1040.10 and 1040.11 except for conformance with IEC 60825-1 Ed.3., as described in Laser Notice No. 56, dated May 8, 2019.

**CLASS 1
LASER PRODUCT**

Range Measurement Performance

Measuring Principle

time of flight measurement, echo signal digitization, online waveform processing

Laser Pulse Repetition Rate PRR ¹⁾	100 kHz	200 kHz reduced power	200 kHz	300 kHz
Max. Measuring Range ²⁾				
natural targets $\rho \geq 20\%$	170 m	150 m	170 m	170 m
natural targets $\rho \geq 60\%$	290 m	250 m	290 m	290 m
natural targets $\rho \geq 80\%$	330 m	280 m	330 m	330 m
Typ. Operating Flight Altitude AGL ^{1) 3)}				
natural targets $\rho \geq 20\%$	100 m (330 ft)	85 m (280 ft)	100 m (330 ft)	100 m (330 ft)
natural targets $\rho \geq 60\%$	160 m (525 ft)	140 m (460 ft)	160 m (525 ft)	160 m (525 ft)
Max. Number of Targets per Pulse ⁴⁾	5	5	5	5

1) Rounded values.
2) Typical values for average conditions. Maximum range is specified for flat targets with size in excess of the laser beam diameter, perpendicular angle of incidence, and for atmospheric visibility of 23 km. In bright sunlight, the max. range is shorter than under overcast sky.
3) Flat terrain assumed, scan angle $\pm 45^\circ$ FOV
4) If more than one target is hit, the total laser transmitter power is split and, accordingly, the achievable range is reduced.

Minimum Range

3 m

Accuracy ^{5) 7)}

15 mm

Precision ^{6) 7)}

10 mm

Laser Pulse Repetition Rate ¹⁾

100 kHz / 200 kHz / 300 kHz (selectable)

Max. Effective Measurement Rate ¹⁾

up to 200 000 meas./sec. (@ 200 kHz PRR reduced power & 360° FOV)

Echo Signal Intensity

for each echo signal, high-resolution 16 bit intensity information is provided

Laser Wavelength

near infrared

Laser Beam Divergence ⁸⁾

1.6 x 0.5 mrad

Laser Beam Footprint

160 mm x 50 mm @ 100 m

5) Accuracy is the degree of conformity of a measured quantity to its actual (true) value.
6) Precision, also called reproducibility or repeatability, is the degree to which further measurements show the same result.

7) One sigma @ 50 m range under RIEGL test conditions.
8) Measured at 50% peak intensity, 1.6 mrad corresponds to an increase of 160 mm of beam diameter per 100 m distance.

Scanner Performance

Scanning Mechanism

rotating mirror

Field of View (selectable)

360° @ 100 kHz, 200 kHz reduced power

180° @ 200 kHz

120° @ 300 kHz

Scan Speed (selectable)

10 - 100 scans/sec⁹⁾ @ 100 kHz, 200 kHz reduced power

20 - 100 scans/sec⁹⁾ @ 200 kHz

30 - 100 scans/sec⁹⁾ @ 300 kHz

Angular Step Width $\Delta \phi$ (selectable)

0.018° ≤ $\Delta \phi$ ≤ 0.36°

between consecutive laser shots

Angle Measurement Resolution

0.001°

9) equivalent to revolutions per second

Interfaces

Configuration, Scan Data Output & Communication with External Devices
GNSS Interface ¹⁰⁾

2 x LAN 10/100/1000 Mbit/sec

WLAN IEEE 802.11 a/b/g/n

Serial RS-232 interface for data string with GNSS-time information,

TTL input for 1PPS synchronization pulse.

Power Output 10 V DC, max 4.5 W

2 x TTL input/output, 1 x Remote on/off

General IO & Control ¹¹⁾

Camera Interface

2 x GNSS RS-232 Tx & PPS, Power (USB 2.0), Trigger, Exposure

Memory Card Slot

for SDHC/SDXC memory card 32 GByte (can be upgraded to 64 GByte)

10) internally available (not available with standard interface box)

11) 1x externally available with standard interface box

General Technical Data

Power Supply Input Voltage / Consumption

11 - 34 V DC / typ. 18 W @ 100 scans/sec

Main Dimensions (L x W x H) / Weight

with Cooling Fan

243 x 111 x 85 mm / approx. 1.6 kg

without Cooling Fan

243 x 99 x 85 mm / approx. 1.55 kg

Humidity

max. 80 % non condensing @ 31°C

Protection Class

IP64, dust and splash-proof

Temperature Range ¹²⁾

-10°C up to +40°C (operation) / -20°C up to +50°C (storage)

12) Continuous operation at ambient temperature of $\geq 30^\circ\text{C}$ ($\geq 86^\circ\text{F}$) requires a minimum amount of air flow at approx. 3 m/s. For applications where a 3 m/s air flow along the cooling fins cannot be guaranteed, the cooling fan has to be used.

PRELIMINARY



RIEGL[®]
LASER MEASUREMENT SYSTEMS

RIEGL
Laser Measurement Systems GmbH
Riedenburgstraße 48
3580 Horn, Austria
Phone: +43 2982 4211
office@riegl.co.at | www.riegl.com

RIEGL USA Inc. | info@rieglusa.com | www.rieglusa.com
RIEGL Japan Ltd. | info@riegl-japan.co.jp | www.riegl-japan.co.jp
RIEGL China Ltd. | info@riegl.cn | www.riegl.cn
RIEGL Australia Pty Ltd. | info@riegl.com.au | www.riegl.com

www.riegl.com